

SHELF SUPPORTS	3	
COUNTER SUPPORTS	3	
PEDESTALS	6	
CONCEALED SUPPORTS	8	
WALL SHELVING	9	
MIRRORS	10	
BINS/TRAYS	11	
GROMMETS	12	
FILE DRAWER	13	
MISCELLANEOUS	14	
		TUBE LEG 14
		WALL ANGLE 14
		LAMINATED WALL CLEAT 14
		CPU MOUNT 14
		CHASE STRUT 14
		TITEJOINT FASTENER JIG 14
		WIRE CHASE 15
		WIRE RACE CHANNEL 15
		CPU/DOOR VENT 15
		LABEL HOLDER 15
		NUMBERED METAL PLATE SET 15

REV. 8/19/21

©2021 STEVENS INDUSTRIES, INC.
ALL RIGHTS RESERVED.
Due to continuing product
development, Stevens reserves
the right to change specifications
without notice.

**SHELF
SUPPORT**



10842

W : 01
H : 05
D : 07

- Available in Black, Grey, White

**COUNTER
SUPPORT**

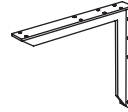

10833

W : 02
H : 14
D : 16

- For 17" and 19" Cabinet Depths
- Available in Black, Grey, White

**SHELF
SUPPORT**



10843

W : 01
H : 08
D : 11

- Available in Black, Grey, White

**COUNTER
SUPPORT**

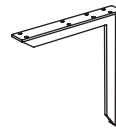

10835

W : 02
H : 16
D : 14

- For 17" Cabinet Depths
- Available in Black, Grey, White

**SHELF
SUPPORT**

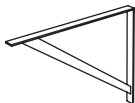

10844

W : 01
H : 10
D : 15

- Available in Black, Grey, White

**COUNTER
SUPPORT**

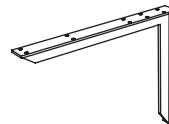

10836

W : 02
H : 16
D : 21

- For 23" Cabinet Depths
- Available in Black, Grey, White

**COUNTER
SUPPORT**

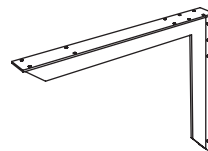

10837

W : 03
H : 21
D : 27

- For 28" Cabinet Depths
- Available in Black, Grey, White

**COUNTER
SUPPORT**



10845

W : 02
H : 05
D : 08

- Available in Black, Grey, White

**COUNTER
SUPPORT**

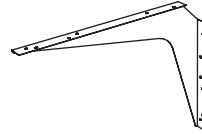

10848

W : 02
H : 18
D : 24

- For 29" Cabinet Depths
- Available in Black, Grey, White

**COUNTER
SUPPORT**

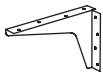

10846

W : 02
H : 08
D : 12

- For 14" and 17" Cabinet Depths
- Available in Black, Grey, White

**COUNTER
SUPPORT**

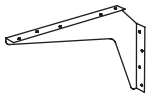

10841

W : 02
H : 12
D : 18

- For 19" Cabinet Depths
- Available in Black, Grey, White

**COUNTER
SUPPORT**

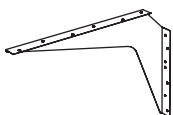

10847

W : 02
H : 15
D : 21

- For 23" Cabinet Depths
- Available in Black, Grey, White

**COUNTER
SUPPORT**

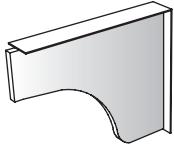

10854

W : 00
H : 16
D : 14, 17, 19, 23

- Apron Counter Support
- Laminate Panel with Metal Cleat
- Depths (D) Indicate Cabinet Depths
- Available with Left or Right Finished End

**COUNTER
SUPPORT**

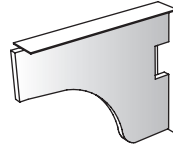

10856

W : 00
H : 16
D : 14, 17, 19, 23

- Apron Counter Support
- Laminate Panel with Metal Cleat
- Standard Wire Chase Cutout
- Depths (D) Indicate Cabinet Depths
- Available with Left or Right Finished End

**COUNTER
SUPPORT**

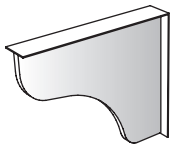

10858

W : 00
H : 16
D : 19, 23

- Laminate Panel with Metal Cleat
- Depths (D) Indicate Cabinet Depths
- Available with Left or Right Finished End

**COUNTER
SUPPORT**

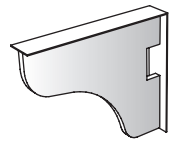

10860

W : 00
H : 16
D : 19, 23

- Laminate Panel with Metal Cleat
- Standard Wire Chase Cutout
- Depths (D) Indicate Cabinet Depths
- Available with Left or Right Finished End

**COUNTER
SUPPORT**

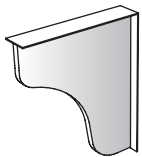

10859

W : 00
H : 21
D : 14, 17

- Laminate Panel with Metal Cleat
- Depths (D) Indicate Cabinet Depths
- Available with Left or Right Finished End

**COUNTER
SUPPORT**

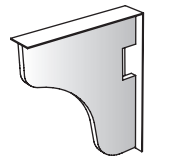

10861

W : 00
H : 21
D : 14, 17

- Laminate Panel with Metal Cleat
- Standard Wire Chase Cutout
- Depths (D) Indicate Cabinet Depths
- Available with Left or Right Finished End

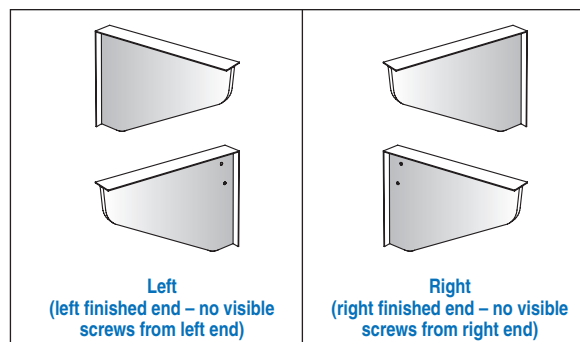

PEDESTAL



10912

W : 00, 01
H : 29, 32, 35
D : 14, 17, 19, 23, 28

- Depths (D) Indicate Cabinet Depths
- Available with Left Finished End, Centered or Right Finished End

PEDESTAL



10913

W : 00, 01
H : 29, 32, 35
D : 14, 17, 19, 23, 28

- Wire Chase Cutout
- Depths (D) Indicate Cabinet Depths
- Available with Left Finished End, Centered or Right Finished End

PEDESTAL



10916

W : 00, 01
H : 29, 32, 35
D : 14, 17, 19, 23, 28

- Depths (D) Indicate Cabinet Depths
- Available with Left Finished End, Centered or Right Finished End

PEDESTAL



10917

W : 00, 01
H : 29, 32, 35
D : 14, 17, 19, 23, 28

- Wire Chase Cutout
- Depths (D) Indicate Cabinet Depths
- Available with Left Finished End, Centered or Right Finished End

PEDESTAL

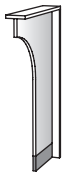

10920

W : 00, 01
H : 29, 32, 35
D : 14, 17, 19, 23, 28

- Apron Pedestal
- Depths (D) Indicate Cabinet Depths
- Available with Left Finished End, Centered or Right Finished End

PEDESTAL



10921

W : 00, 01
H : 29, 32, 35
D : 14, 17, 19, 23, 28

- Apron Pedestal
- Wire Chase Cutout
- Depths (D) Indicate Cabinet Depths
- Available with Left Finished End, Centered or Right Finished End

PEDESTAL

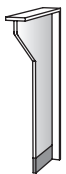

10928

W : 00, 01
H : 29, 32, 35
D : 14, 17, 19, 23, 28

- Depths (D) Indicate Cabinet Depths
- Available with Left Finished End, Centered or Right Finished End

PEDESTAL

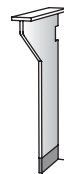

10929

W : 00, 01
H : 29, 32, 35
D : 14, 17, 19, 23, 28

- Wire Chase Cutout
- Depths (D) Indicate Cabinet Depths
- Available with Left Finished End, Centered or Right Finished End

PEDESTAL



10812

W : 00, 01
H : 29, 32, 35
D : 14, 17, 19, 23, 28

- Depths (D) Indicate Cabinet Depths
- Includes 4 L-brackets

PEDESTAL



10813

W : 00, 01
H : 29, 32, 35
D : 14, 17, 19, 23, 28

- Wire Chase Cutout
- Depths (D) Indicate Cabinet Depths
- Includes 4 L-brackets

PEDESTAL



10816

W : 00, 01
H : 29, 32, 35
D : 14, 17, 19, 23, 28

- Depths (D) Indicate Cabinet Depths
- Includes 4 L-brackets

PEDESTAL



10817

W : 00, 01
H : 29, 32, 35
D : 14, 17, 19, 23, 28

- Wire Chase Cutout
- Depths (D) Indicate Cabinet Depths
- Includes 4 L-brackets

PEDESTAL



10820

W : 00, 01
H : 29, 32, 35
D : 14, 17, 19, 23, 28

- Apron Pedestal
- Depths (D) Indicate Cabinet Depths
- Includes 4 L-brackets

PEDESTAL



10821

W : 00, 01
H : 29, 32, 35
D : 14, 17, 19, 23, 28

- Apron Pedestal
- Wire Chase Cutout
- Depths (D) Indicate Cabinet Depths
- Includes 4 L-brackets

PEDESTAL



10828

W : 00, 01
H : 29, 32, 35
D : 14, 17, 19, 23, 28

- Depths (D) Indicate Cabinet Depths
- Includes 4 L-brackets

PEDESTAL



10829

W : 00, 01
H : 29, 32, 35
D : 14, 17, 19, 23, 28

- Wire Chase Cutout
- Depths (D) Indicate Cabinet Depths
- Includes 4 L-brackets

**CONCEALED
SUPPORT (IN-WALL)**



10976

W : 02
H : 12
D : 12

- For 14" Cabinet Depths
- Available in Black
- All Welds on Reverse for Easy, Clean Install
- Recommend Backing When Used with Metal Studs

**CONCEALED
SUPPORT (IN-WALL)**



10980

W : 02
H : 18
D : 24

- For 28" Cabinet Depths
- Available in Black
- All Welds on Reverse for Easy, Clean Install
- Recommend Backing When Used with Metal Studs

**CONCEALED
SUPPORT (IN-WALL)**

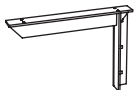

10977

W : 02
H : 12
D : 15

- For 17" Cabinet Depths
- Available in Black, White
- All Welds on Reverse for Easy, Clean Install
- Recommend Backing When Used with Metal Studs

**CONCEALED
SUPPORT (IN-WALL)**



10978

W : 02
H : 18
D : 18

- For 19" Cabinet Depths
- Available in Black
- All Welds on Reverse for Easy, Clean Install
- Recommend Backing When Used with Metal Studs

**CONCEALED
SUPPORT (IN-WALL)**



10979

W : 02
H : 18
D : 21

- For 23" Cabinet Depths
- Available in Black, White
- All Welds on Reverse for Easy, Clean Install
- Recommend Backing When Used with Metal Studs

**KV82
UPRIGHT**



15901	BLACK
15902	WHITE
15903	GREY

W : 01
H : 28, 48, 63, 78
D : 00

- KV82 Heavy Duty Upright
- 14-ga. Steel
- Double Slot Design
- Available in Black, White, Grey Powder Coat

**KV82
BRACKET**



15905	BLACK
15906	WHITE
15907	GREY

W : 00
H : 03
D : 11, 13, 15

- KV82 Heavy Duty Bracket
- 16-ga. Steel
- Vertically Adjustable in 1 1/4" Increments
- Double Lug Design
- Available in Black, White, Grey Powder Coat

**DEMONSTRATION
MIRROR**

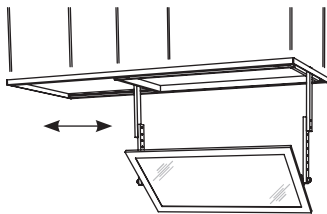

10958

W : 48, 59
H : VARIES
D : 28

- Movable, Ceiling Mount
- Track Length: 96"
- 12" Adjustment to Accommodate Ceiling Height
- Ceiling Mounted with 1/2" Threaded Rods (included)
- 48W: 47W Mirror Frame
- 59W: 58W Mirror Frame

**DEMONSTRATION
MIRROR**

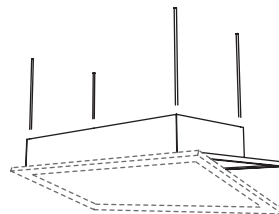

10961

W : 67
H : VARIES
D : 26

- Motorized, Ceiling Mount
- Ceiling Mounted with 1/2" Threaded Rods (included)
- 67" x 26" Framed Mirror
- Motorized 110V Tilt with Power Remote

**DEMONSTRATION
MIRROR**

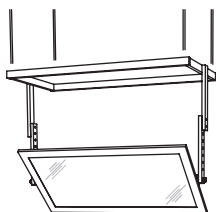

10959

W : 48, 59
H : VARIES
D : 26

- Ceiling Mount
- 12" Adjustment to Accommodate Ceiling Height
- Ceiling Mounted with 1/2" Threaded Rods (included)
- 48W: 47W Mirror Frame
- 59W: 58W Mirror Frame

**WARDROBE
MIRROR**



10898

W : 10
H : 10
D : 00

- Acrylic
- Adhesive Backed

**DEMONSTRATION
MIRROR**

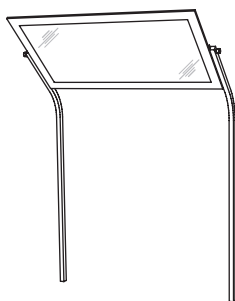

10960

W : 48, 59
H : VARIES
D : 26

- Cabinet Mount
- Pivoting
- 48W: 43W Mirror Frame for Cabinets 48W and Wider
- 59W: 54W Mirror Frame for Cabinets 59W and Wider

BIN

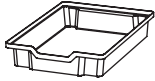

SA910

W : 12
H : 03
D : 17

- Molded Translucent Bin
- Outside: 12 1/4W x 3H x 16 3/4D
- Inside: 10 5/8W x 3H x 14 1/4D

**TRASH
BIN**



10904

W : 14
H : 15
D : 10

- Plastic with Rolled Rim
- 28-qt. / 7-gal. Capacity
- Outside: 14 3/8W x 15H x 10 1/4D

BIN

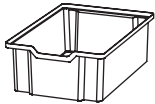

SA911

W : 12
H : 06
D : 17

- Molded Translucent Bin
- Outside: 12 1/4W x 6H x 16 3/4D
- Inside: 10 5/8W x 6H x 14 1/4D

**TRASH
BIN**

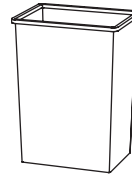

10905

W : 15
H : 20
D : 11

- Plastic with Rolled Rim
- 40-qt. / 10-gal. Capacity
- Outside: 15 1/4W x 20H x 11 1/8D

BIN

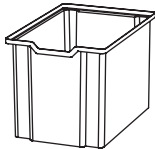

SA912

W : 12
H : 12
D : 17

- Molded Translucent Bin
- Outside: 12 1/4W x 12H x 16 3/4D
- Inside: 10 5/8W x 12H x 14 1/4D

**TRASH
BIN**

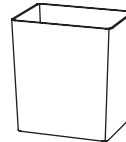

10906

W : 15
H : 16
D : 11

- Fiberglass Construction
- 28-qt. / 7-gal. Capacity
- Outside: 14 1/2W x 15 1/2H x 10 1/2D

TRAY



SA901

W : 14
H : 04
D : 19

- Pearl White Molded Tray
- Card Holder on 14 1/4" Side
- Outside: 14 1/4W x 3 1/2H x 19D
- Inside: 12 3/4W x 3 1/2H x 17 1/4D

**TRASH
BIN**

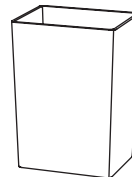

10907

W : 15
H : 20
D : 12

- Fiberglass Construction
- 40-qt. / 10-gal. Capacity
- Outside: 15W x 20 1/4H x 11 1/2D

TRAY



SA902

W : 10
H : 04
D : 19

- Pearl White Molded Tray
- Card Holder on 10" Side
- Outside: 10W x 3 1/2H x 19D
- Inside: 8 1/2W x 3 1/2H x 17 1/4D

KEYBOARD TRAY

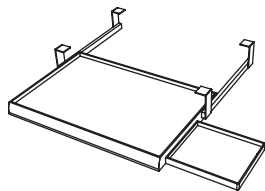

10881

W : 25
H : 05
D : 15

- Black Molded Keyboard Tray with Mouse Extension
- 22W x 9D Keyboard Space
- 8W x 9D Mouse Extension (Left or Right)
- Requires 24 1/2" Opening

GROMMET



10895

W : 04
H : 01
D : 04

- 3 1/4" Diameter Pass-Thru
- Available in Black, Grey, White
- Actual Size: 3 5/8" Dia. x 1"H

KEYBOARD TRAY

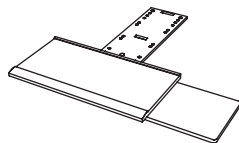

10884

W : 21
H : 03
D : 17

- Black Articulating Adjustable Arm and Keyboard Tray with Mouse Extension
- 21W x 9D Keyboard Space
- 9W x 9D Mouse Extension

TRASH GROMMET

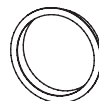

10888

W : 07
H : 07
D : 01

- Available in Black, Grey, White

PENCIL DRAWER TRAY

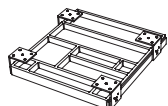

10879

W : 13
H : 01
D : 14

- Black Molded Compartment Tray
- Compartments May Vary From Illustration

TRASH GROMMET

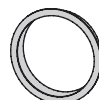

10889

W : 07
H : 07
D : 01

- Stainless Steel

PENCIL DRAWER TRAY

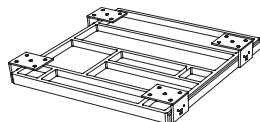

10882

W : 22
H : 01
D : 16

- Black Molded Compartment Tray
- Compartments May Vary From Illustration

FILE CROSSBARS

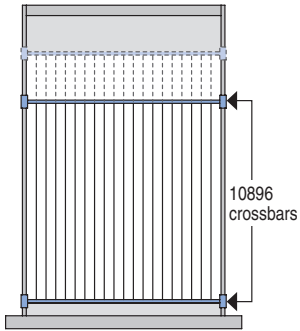

Letter File Drawer
with optional crossbars
installed for side filing

10896

W : 15
H : 01
D : 00

- Pair of Crossbars for 15W File Drawers (Letter)
- Allow Side Filing

FILE CROSSBARS

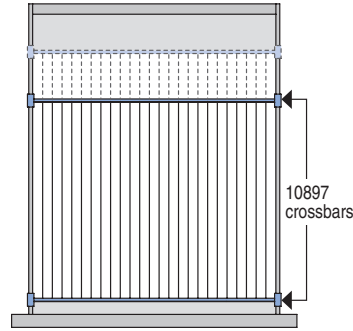

Legal File Drawer
with optional crossbars
installed for side filing

10897

W : 18
H : 01
D : 00

- Pair of Crossbars for 18W File Drawers (Legal)
- Allow Side Filing

FILE BARS

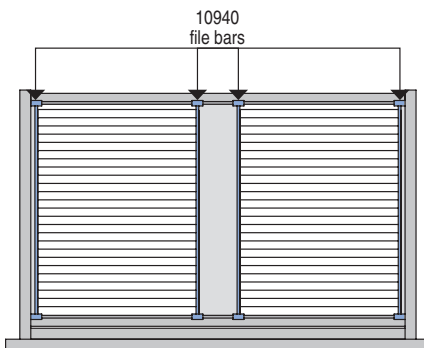

Lateral File Drawer
with two pairs of optional file bars
installed for front-to-back filing

10940

W : 00
H : 01
D : 18

- 1 Pair of File Bars for Lateral File Drawers
- Allow Front-to-Back Filing
- 1 Pair Required for 24W Lateral File Drawers
- 2 Pairs Required for 36W Lateral File Drawers

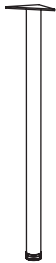
**TUBE
LEG**

10831

W : 02
H : 29, 32, 35
D : 02

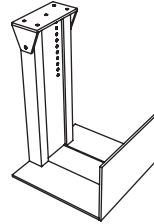
- Adjustable Leveler
- Chrome

**CPU
MOUNT**

10894

W : 09
H : 13
D : 05

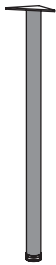
- Fixed Mount
- Black
- Width Adjustment: 5 1/2" to 9 1/4"
- Height Adjustment: 13 3/8" to 20 1/2"

**TUBE
LEG**

10832

W : 02
H : 29, 32, 35
D : 02

- Adjustable Leveler
- Powder Coated Black

**CHASE
STRUT**

10933

W : 02
H : 29, 32, 35
D : 06, 08, 12

- Actual Depths Match Chase Sizes Shown in Design Information Section (See Chart Below)

Nominal Depth	Actual Depth
06	Adjustable for chase sizes 5" to 6 1/2"
08	Adjustable for chase sizes 6 1/2" to 8"
12	Adjustable for chase sizes 10" to 12"

**WALL
ANGLE**

10838

W : 21
H : 01
D : 01

- For Attachment of Countertop to Wall or Adjacent Structure
- Black

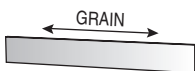
**LAMINATED
WALL CLEAT**

10890

W : 24, 30, 48, 96
H : 04, 06
D : 00

- 3/4" Edgebanded Laminated Cleat

**TITEJOINT
FASTENER JIG**

10974

W : 25
H : 00
D : 06

- Template for Routing Countertops in the Field for Application of Titejoint Fasteners
- Titejoint Fasteners Not Included
- Actual Size: 25W x 6D x 3/4" Thick

WIRE CHASE

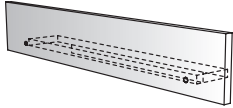

10885

W : 24, 30, 33, 36, 39, 42, 45, 48
H : 06
D : 05

- Laminated Wire Chase

LABEL HOLDER



10911

W : 05
H : 02
D : 00

- For File Drawers
- Metal Label Holder with Slot for Label Insert
- Actual Size: 4 5/8W x 1 3/4H

WIRE RACE CHANNEL

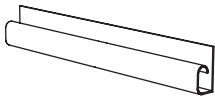

10886

W : 48, 96
H : 02
D : 01

- Black Extrusion
- Adhesive Backed
- Actual Size: 2 3/8H x 1 1/8D
- Field Trim to Fit

LABEL HOLDER



10908

W : 02
H : 00
D : 00

- For Shelf Front Edge
- Self Adhesive Anodized Aluminum Label Holder
- Actual Size: 2W x 3/4H

CPU/DOOR VENT



10892

W : 04
H : 03
D : 00

- Available in Black, Grey, White

NUMBERED METAL PLATE SET



10899

W : 02
H : 01
D : 01, 02, 03, 04

- Black Enamel-Filled Consecutive Numbers Stamped onto 18-ga. Aluminum Plates
- Order in Sets of 25 Plates
- Depth (D) Indicates Number Range, as follows:
01: 001-025
02: 026-050
03: 051-075
04: 076-100

DOOR VENT

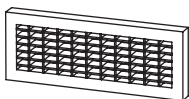

10893

W : 09
H : 03
D : 00

- Available in Black, Grey, White
- 2 Per Cutout Required