

48H	3	SHELF	3
		CORNER	4
		DISPLAY	4
		INSTRUCTOR WHITE BOARD	5
54H	6	SHELF	6
		CORNER	7
		DISPLAY	7
INSTALLATION ACCESSORIES	9	SOFFIT TRIM	9
		VERTICAL SCRIBE	9
		FILLERS	9
		CLOSURES	9
		SOFFIT FASCIAS	9
DESIGN DETAILS	10		



SHELF



**43101**

W : 12, 14, 15, 17, 18, 20, 21, 23, 24, 28,  
30, 34, 35, 36  
H : 48  
D : 14, 17

- Adjustable Shelves: 3

SHELF



**43138**

W : 24, 28, 30, 34, 36, 40, 42, 46, 48  
H : 48  
D : 14, 17

- Center Divider
- Adjustable Shelves: 6

SHELF



**43120**

W : 12, 14, 15, 17, 18, 20, 21, 23, 24  
H : 48  
D : 14, 17

- Right Hinge Door
- Adjustable Shelves: 3

SHELF



**43181**

W : 24, 28, 30, 34, 36, 40, 42, 46, 48  
H : 48  
D : 14, 17

- Doors
- Center Divider
- Adjustable Shelves: 6

SHELF



**43121**

W : 12, 14, 15, 17, 18, 20, 21, 23, 24  
H : 48  
D : 14, 17

- Left Hinge Door
- Adjustable Shelves: 3

SHELF



**43150**

W : 36, 40, 42, 46, 48  
H : 48  
D : 14, 17

- Sliding Doors
- Center Divider
- Adjustable Shelves: 6

SHELF

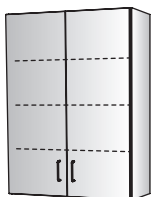

**43129**

W : 24, 28, 30, 34, 36  
H : 48  
D : 14, 17

- Doors
- Adjustable Shelves: 3

**DIAGONAL  
CORNER**



**43211**

W : 25  
H : 48  
D : 14

W : 28  
H : 48  
D : 17

- Right Hinge Door
- Fixed Shelves: 3

**DISPLAY**



**43130**

W : 15, 17, 18, 20, 21, 23, 24  
H : 48  
D : 14, 17

- Right Hinge Display Door
- Adjustable Shelves: 3

**DIAGONAL  
CORNER**



**43212**

W : 25  
H : 48  
D : 14

W : 28  
H : 48  
D : 17

- Left Hinge Door
- Fixed Shelves: 3

**DISPLAY**



**43131**

W : 15, 17, 18, 20, 21, 23, 24  
H : 48  
D : 14, 17

- Left Hinge Display Door
- Adjustable Shelves: 3

**DISPLAY**



**43182**

W : 30, 34, 36, 40, 42, 46, 48  
H : 48  
D : 14, 17

- Display Doors
- Center Divider
- Adjustable Shelves: 6

**DISPLAY**



**43154**

W : 36, 40, 42, 46, 48  
H : 48  
D : 14, 17

- Sliding Display Doors
- Center Divider
- Adjustable Shelves: 6

**DISPLAY**



**43158**

W : 36, 40, 42, 46, 48  
H : 48  
D : 14, 17

- Sliding Glass Doors
- Center Divider
- Adjustable Shelves: 6

**INSTRUCTOR  
WHITE BOARD**

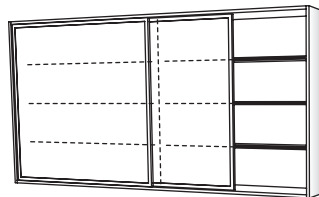

**43300**

W : 72, 96  
H : 48  
D : 17

- 2 Sliding White Boards
- 2 Tracks
- Center Divider
- Adjustable Shelves: 6

**INSTRUCTOR  
WHITE BOARD**

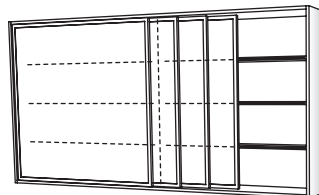

**43302**

W : 72, 96  
H : 48  
D : 17

- 4 Sliding White Boards
- 4 Tracks
- Center Divider
- Adjustable Shelves: 6

**SHELF**



**43101**

W : 12, 14, 15, 17, 18, 20, 21, 23, 24, 28,  
30, 34, 35, 36  
H : 54  
D : 14, 17

- Adjustable Shelves: 3

**SHELF**



**43138**

W : 24, 28, 30, 34, 36, 40, 42, 46, 48  
H : 54  
D : 14, 17

- Center Divider
- Adjustable Shelves: 6

**SHELF**

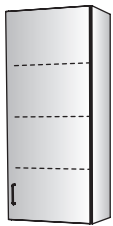

**43120**

W : 12, 14, 15, 17, 18, 20, 21, 23, 24  
H : 54  
D : 14, 17

- Right Hinge Door
- Adjustable Shelves: 3

**SHELF**

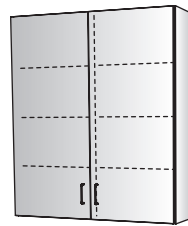

**43181**

W : 24, 28, 30, 34, 36, 40, 42, 46, 48  
H : 54  
D : 14, 17

- Doors
- Center Divider
- Adjustable Shelves: 6

**SHELF**



**43121**

W : 12, 14, 15, 17, 18, 20, 21, 23, 24  
H : 54  
D : 14, 17

- Left Hinge Door
- Adjustable Shelves: 3

**SHELF**



**43150**

W : 36, 40, 42, 46, 48  
H : 54  
D : 14, 17

- Sliding Doors
- Center Divider
- Adjustable Shelves: 6

**SHELF**

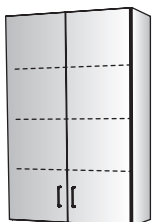

**43129**

W : 24, 28, 30, 34, 36  
H : 54  
D : 14, 17

- Doors
- Adjustable Shelves: 3

**DIAGONAL  
CORNER**



**43211**

W : 25  
H : 54  
D : 14

W : 28  
H : 54  
D : 17

- Right Hinge Door
- Fixed Shelves: 3

**DISPLAY**



**43130**

W : 15, 17, 18, 20, 21, 23, 24  
H : 54  
D : 14, 17

- Right Hinge Display Door
- Adjustable Shelves: 3

**DIAGONAL  
CORNER**



**43212**

W : 25  
H : 54  
D : 14

W : 28  
H : 54  
D : 17

- Left Hinge Door
- Fixed Shelves: 3

**DISPLAY**



**43131**

W : 15, 17, 18, 20, 21, 23, 24  
H : 54  
D : 14, 17

- Left Hinge Display Door
- Adjustable Shelves: 3

**DISPLAY**



**43182**

W : 30, 34, 36, 40, 42, 46, 48  
H : 54  
D : 14, 17

- Display Doors
- Center Divider
- Adjustable Shelves: 6

**DISPLAY**



**43154**

W : 36, 40, 42, 46, 48  
H : 54  
D : 14, 17

- Sliding Display Doors
- Center Divider
- Adjustable Shelves: 6

DISPLAY



**43158**

W : 36, 40, 42, 46, 48  
H : 54  
D : 14, 17

- Sliding Glass Doors
- Center Divider
- Adjustable Shelves: 6



## SOFFIT TRIM



### 15801

W : 96  
H : 00  
D : 03

- Field Trim to Fit
- Actual Thickness: 3/4"
- Actual Depth: 3"
- Edgebanding: One Long Edge in Casebody Trim Color and 0.5mm Thickness

## TOP CORNER CLOSURE

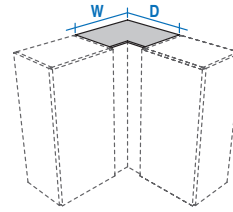

Shown with  
22805 Corner Filler

### 22809

W : 16, 18, 20, 21, 23, 24, 26  
H : 00  
D : 16, 18, 20, 21, 23, 24, 26

- Field Trim to Fit
- Edgebanding: None

## VERTICAL SCRIBE



### 15802

W : 00  
H : 96  
D : 14, 17

- Field Trim to Fit
- Actual Thickness: 3/4"
- Actual Depth: 3"
- Edgebanding: One Long Edge in Casebody Trim Color and 0.5mm Thickness

## END SOFFIT CLOSURE

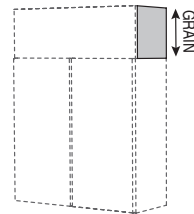

Shown with  
15822/15823  
Soffit Fascia

### 15820

W : 00  
H : 12, 18, 24  
D : 14, 17

- Vertical Grain
- Field Trim to Fit
- Edgebanding: All Edges in Casebody Trim Color and 0.5mm Thickness

## FRONT FILLER

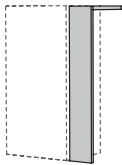

### 22803

W : 02, 03, 06, 09, 12  
H : 48, 54  
D : 14, 17

- Field Trim to Fit
- Includes Top Closure Panel
- Edgebanding: Two Short Edges in Casebody Trim Color and 0.5mm Thickness

## SOFFIT FASCIA

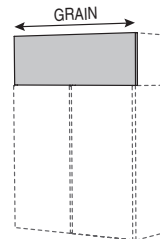

Shown with  
15820 End  
Soffit Closure

### 15822

W : 12, 14, 15, 17, 18, 20, 21, 23,  
24, 28, 30, 34, 35, 36, 40,  
42, 46, 48, 96  
H : 12, 18, 24  
D : 00

- Horizontal Grain
- Field Trim to Fit
- Edgebanding: One Long and Two Short Edges in Casebody Trim Color and 0.5mm Thickness

## CORNER FILLER

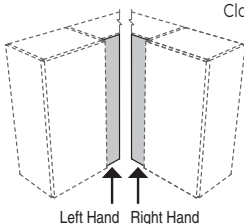

Shown with  
22809 Top Corner  
Closure

Left Hand Right Hand

### 22805

W : 03, 06, 09, 12  
H : 48, 54  
D : 14, 17

- Field Trim to Fit
- Depths Listed are Depths of Cabinets to which Filler is Attached
- Edgebanding: Two Short Edges in Casebody Trim Color and 0.5mm Thickness

## SOFFIT FASCIA

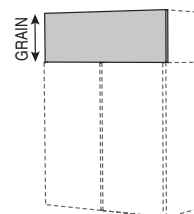

Shown with  
15820 End  
Soffit Closure

### 15823

W : 12, 14, 15, 17, 18, 20, 21, 23,  
24, 28, 30, 34, 35, 36, 40,  
42, 46, 48  
H : 12, 18, 24  
D : 00

- Vertical Grain
- Field Trim to Fit
- Edgebanding: One Short and Two Long Edges in Casebody Trim Color and 0.5mm Thickness

Hutch design is for stacking on 35H base unit with 1" (25mm) countertop thickness. Actual hutch heights are provided based on overall total height of elevation.

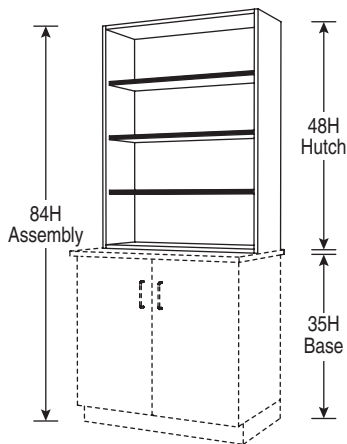
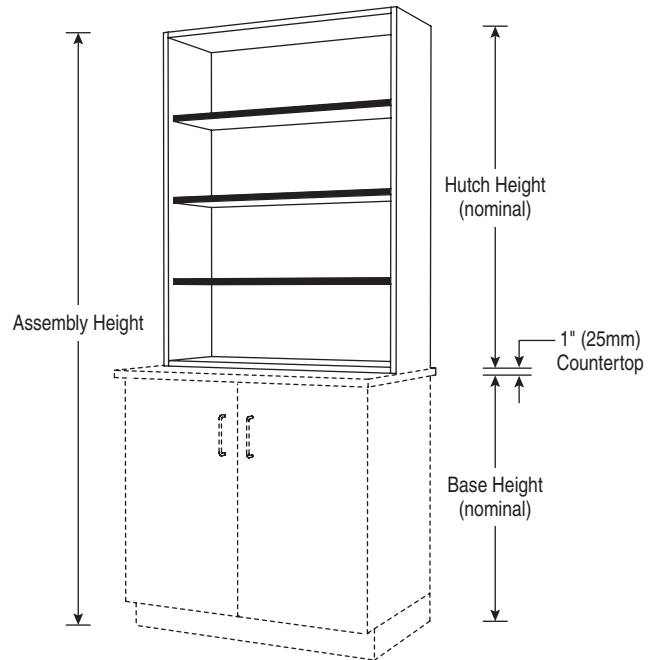

**HUTCH ASSEMBLY DIMENSIONS**

Assembly Height (nominal)	Assembly Height (actual)	Base Height (nominal)	Hutch Height (nominal)	Hutch Height* (actual)	
in.	in.	mm	in.	in.	mm
84	84 1/8	2137	35	48	48 1/8 1223
90	90 7/16	2297	35	54	54 7/16 1383

\*includes 1" (25mm) countertop

